

Iwaki

Electromagnetic Metering Pump

EJ-B(R) (Europe)

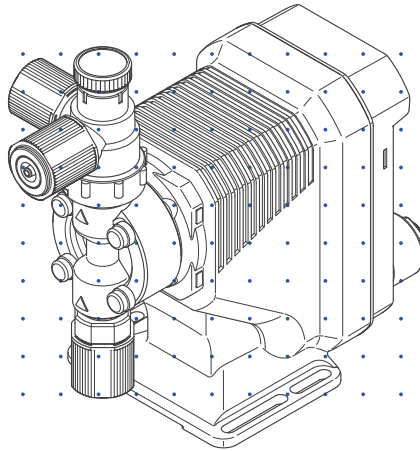

Instruction manual

Thank you for choosing our product.



Please read through this instruction manual before use.

This instruction manual describes important precautions and instructions for the product. Always keep it on hand for quick reference.

Order confirmation



Open the package and check that the product conforms to your order. If any problem or inconsistency is found, immediately contact your distributor.

a. Check if the delivery is correct.

Check the nameplate to see if the information such as model codes, discharge capacity and discharge pressure are as ordered.

Iwaki Metering Pump		VOLTAGE	V
MODEL		CURRENT	A
PRESSURE	MPa	FREQUENCY	Hz
CAPACITY	L/H	MFG.No.	
STROKE RATE	spm	Year :	1P427118

IWAKI CO.,LTD. MADE IN JAPAN
6-6 Kanda-Sudacho 2-chome Chiyoda-ku Tokyo Japan



b. Check if the delivery is damaged or deformed.

Check for transit damage and loose bolts.

Contents

Order confirmation	2
Safety instructions	6
Warning.....	7
Caution.....	8
Precautions for use	10
Overview.....	12
Introduction.....	12
Pump structure & Operating principle	12
Features.....	13
Operational functions	13
Manual mode	13
EXT mode.....	14
STOP function	14
Part names.....	15
Pump.....	15
Operational panel	16
Basic displays & Pump states	17
Identification codes.....	18
Installation	19
Pump mounting.....	19
Pipework.....	20
Tube connection	20
Check valve mounting	22
Wiring.....	24
Power voltage/Earthing	24
Signal wire connection.....	26
Input signal	27

Operation.....28

Before operation 28

- Points to be checked 28
- Retightening of pump head fixing bolts 28
 - Use of hexagon wrench instead of a torque wrench 29
- Degassing..... 29
- Flow rate adjustment 32
- Before a long period of stoppage (one month or more)..... 34

Operation programming 35

- Programming flow..... 35
- Manual operation 36
- EXT operation..... 38
- STOP function 39
- Keypad lock 40
 - Keypad lock activation..... 40
 - Keypad lock release 40

Maintenance.....41

Troubleshooting..... 42

Inspection 43

- Daily inspection 43
- Periodic inspection 43

Wear part replacement..... 44

- Wear part list..... 44
- Before replacement 45
- Valve set replacement 46
 - Discharge valve set dismantlement/assembly 46
 - Suction valve set dismantlement/assembly 48
- Diaphragm replacement 49

Exploded view	52
Pump head & Drive unit	52
Pump head	53
Specifications/Outer dimensions	54
Specifications	54
Pump unit	54
Control unit	55
European power cable	55
Australian power cable	55
Pump colour	55
Outer dimensions.....	56
EJ-B09/-B11/-B16/-B21 VC/VH.....	56
EJ-B11/-B16/-B21 TC	57
EC Declaration of Conformity.....	58

Safety instructions

Read through this section before use. This section describes important information for you to prevent personal injury or property damage.

■ Symbols

In this instruction manual, the degree of risk caused by incorrect use is noted with the following symbols. Please pay attention to the information associated with the symbols.



WARNING

Indicates mishandling could lead to a fatal or serious accident.



CAUTION

Indicates mishandling could lead to personal injury or property damage.

A symbol accompanies each precaution, suggesting the use of "Caution", "Prohibited actions" or specific "Requirements".

Caution marks



Caution



Electrical shock

Prohibited mark



Prohibited



Do not rework or alter

Requirement mark



Requirement



Wear protection



Grounding



Export Restrictions

Technical information contained in this instruction manual might be treated as controlled technology in your countries, due to agreements in international regime for export control.

Please be reminded that export license/permission could be required when this manual is provided, due to export control regulations of your country.

! WARNING**Turn off power before service**

Risk of electrical shock. Be sure to turn off power to stop the pump and related devices before service is performed.



Electrical shock

Stop operation

If you notice any abnormal or dangerous conditions, suspend operation immediately and inspect/solve problems.



Requirement

Do not use the pump in any condition other than its intended purpose

The use of the pump in any conditions other than those clearly specified may result in failure or injury. Use this product in specified conditions only.



Prohibited

Do not modify the pump

Alterations to the pump carries a high degree of risk. It is not the manufacturer's responsibility for any failure or injury resulting from alterations to the pump.



Do not rework or alter

Wear protective clothing

Always wear protective clothing such as an eye protection, chemical resistant gloves, a mask and a face shield during disassembly, assembly or maintenance work. The specific solution will dictate the degree of protection. Refer to MSDS precautions from the solution supplier.



Wear protection

Do not damage the power cable

Do not pull, knot, or crush the power cable. Damage to the power cable could lead to a fire or electrical shock if cut or broken.



Prohibited

Do not operate the pump in a flammable atmosphere

Do not place explosive or flammable material near the pump.



Prohibited

CAUTION

Qualified personnel only

The pump should be handled or operated by qualified personnel with a full understanding of the pump. Any person not familiar with the product should not take part in the operation or maintenance of the pump.



Requirement

Use specified power only

Do not apply power other than that specified on the nameplate. Otherwise, failure or fire may result. Ensure the pump is properly grounded.



Prohibited

Do not run pump dry

Do not run pump dry for more than 30 minutes (even when the pump runs for degassing). Otherwise, the pump head fixing screws may loosen and liquid may leak. Optimise your system. If the pump runs dry for a long period (for more than 30 minutes), the pump head and the valve cases may deform by friction heat and consequently leakage results.



Caution

Keep electric parts and wiring dry

Risk of fire or electric shock. Install the pump where it can be kept dry.



Prohibited

Observe an applicable MSDS

Take account of installation environment. Chemicals should be controlled in accordance with a MSDS. Do not send potable water or circulate heated water with this pump.



Caution

Do not install /store the pump:

- In a flammable atmosphere or a dusty/humid environment.
- Where ambient temperature can exceed 0-40°C.
- In direct sunlight or wind & rain.



Prohibited

Spill precautions

Ensure protection and containment of solution in the event of plumbing or pump damage (secondary containment).



Requirement

Do not use the pump in a wet location

The pump is not waterproof. Use of the pump in wet or extremely humid locations could lead to electric shock or short circuit.



Grounding

Risk of electrical shock! Always properly ground the pump. Conform to local electric codes.



Install a GFCI (earth leakage breaker)

An electrical failure of the pump may adversely affect other devices on the same line. Purchase and install a GFCI (earth leakage breaker) separately.



Preventative maintenance

Follow instructions in this manual for replacement of wear parts. Do not disassemble the pump beyond the extent of the instructions.



Do not use a damaged pump

Use of a damaged pump could lead to an electric shock or death.



Disposal of a used pump

Dispose of any used or damaged pump in accordance with local rules and regulations. If necessary, consult a licensed industrial waste disposal company.



Check pump head bolts

Liquid may leak if any of the pump head bolts become loose. Tighten the bolts diagonally and evenly by 2.16N•m before initial operation and at regular intervals.



Solution compatibility

This pump has been evaluated for use with water only. The suitability of this pump for use with liquids other than water, such as acid and alkaline, is the responsibility of the user. For liquids other than water, select the best-suited liquid end material combination using a chemical compatibility chart.



Precautions for use

- Electrical work should be performed by a qualified electrician. Otherwise, personal injury or property damage could result.



- Do not install the pump:
 - In a flammable atmosphere.
 - In a dusty/humid place.
 - In direct sunlight or wind & rain.
 - Where ambient temperature can exceed 0-40°C.Protect the pump with a cover when installing it out of doors.

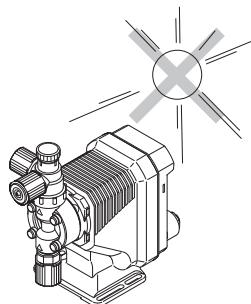

- Select a level location, free from vibration, that won't hold liquid. Anchor the pump with four M5 bolts so it doesn't vibrate. If the pump is not installed level, output may be affected.

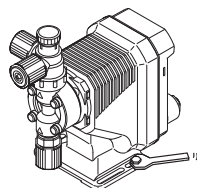

- When two or more pumps are installed together, vibration may be significant, resulting in poor performance or failure. Select a solid foundation (concrete) and fasten anchor bolts securely to prevent vibration during operation.



- Allow sufficient space around the pump for easy access and maintenance.



- Install the pump as close to the supply tank as possible.



- When handling liquids that generate gas bubbles (sodium hypochlorite or hydrazine solution), install the pump in a cool and dark place. Flooded suction installation is strongly recommended.



- Use care handling the pump. Do not drop. An impact may affect pump performance. Do not use a pump that has been damaged to avoid the risk of electrical damage or shock.

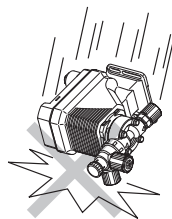

- The pump has a rating of IP65 equivalent, but is not waterproof. Do not operate the pump while wet with solution or water. Failure or injury may result. Immediately dry off the pump if it gets wet.



Caution

- Do not close discharge line during operation. Solution may leak or piping may break. Install a relief valve to ensure safety and prevent damaged plumbing.



Caution

- Solution in the discharge line may be under pressure. Release the pressure from the discharge line before disconnecting plumbing or disassembly of the pump to avoid solution spray.



Requirement

- Wear protective clothing when handling or working with pumps. Consult solution MSDS for appropriate precautions. Do not come into contact with residual solution.



Caution

- Do not clean the pump or nameplate with a solvent such as benzene or thinner. This may discolor the pump or erase printing. Use a dry or damp cloth or a neutral detergent.



- Install a relief valve on a discharge line near the pump so as to release the discharge pressure when it exceeds the maximum level.



Requirement

Overview

Pump characteristics, features and part names are described in this section.

Introduction

Pump structure & Operating principle

The EJ series is a diaphragm metering pump which consists of a pump head and a drive unit with a built-in controller. A diaphragm is directly driven by electromagnetic force.

Principle of operation

The pulse signal via the PCB generates the electromagnetic force to make reciprocating motion with the assistance of the spring force. The reciprocating motion is transferred to a diaphragm through a plunger and then volumetric change occurs in the pump head. This action transfers liquid along with pump head valve action.

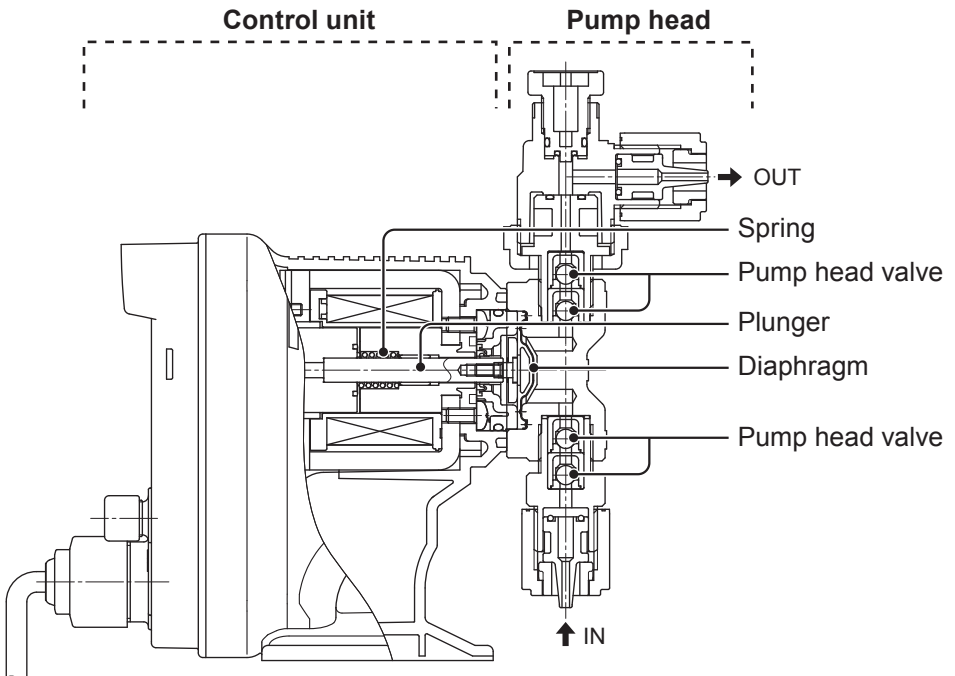

Features

- **Multivoltage operation**

The EJ series is a multivoltage type (100-240VAC) and can be selected without local power limitations.

- **High turndown ratio**

Digitally-controlled spm range is 1-360spm.

- **IP rating of 65 equivalent**

This pump is not waterproof. Protect the pump with a cover when installing it out of doors.

Operational functions

Manual mode

Run/stop the pump by the start/stop key. A stroke rate (MAN speed) can be changed in the range of 1-360spm by the up key at any time during operation or stop. See page 36 for detail.

*The pump can also be turned ON/OFF by switching the main power.

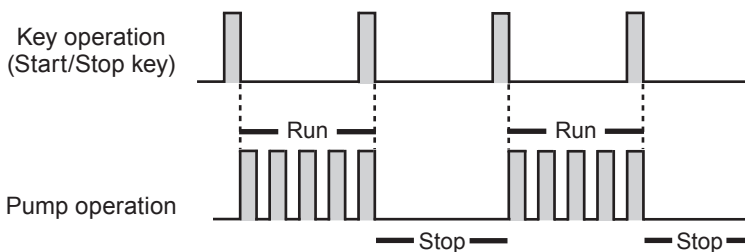

EXT mode

The pump operation by the external signal. In this mode, the multiplier is fixed to 1 and the pump makes one shot at every input of the signal. See page 38 for detail.

Example) The pump makes one shot per signal.

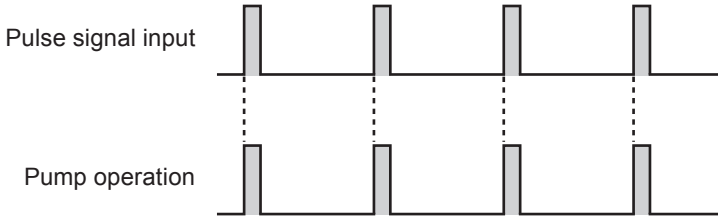

STOP function

The start/stop of the pump can be controlled by the external STOP signal. See page 39 for detail.

*The pump resumes operation when the STOP signal is released.

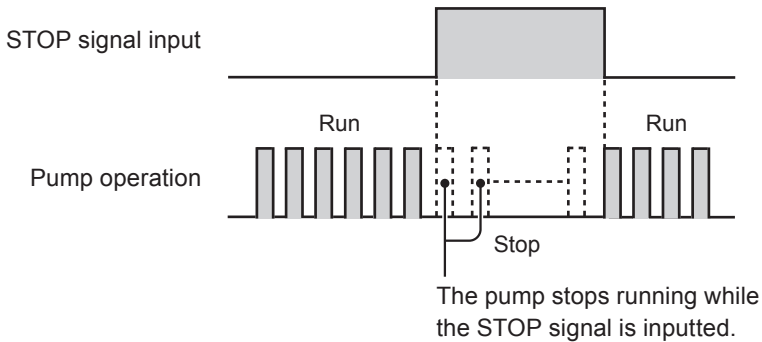

Pump

Air vent port

Always connect a tube. Be sure to return the tube end to a supply tank or a container.

A circumferential direction of the port can be changed up to 90 degrees counterclockwise from the original position.

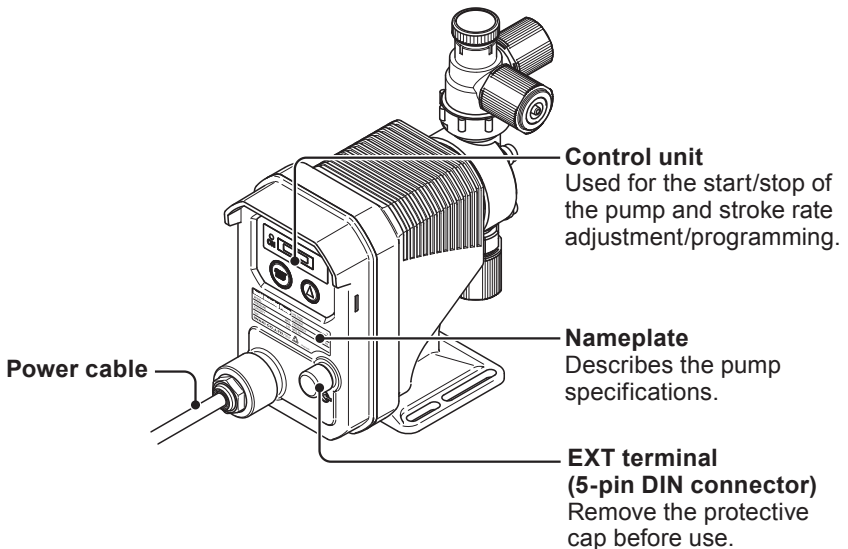
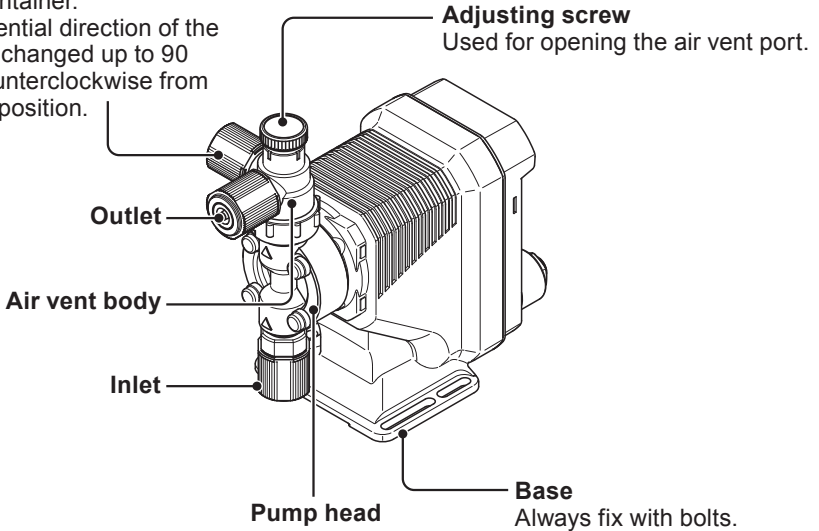

Operational panel

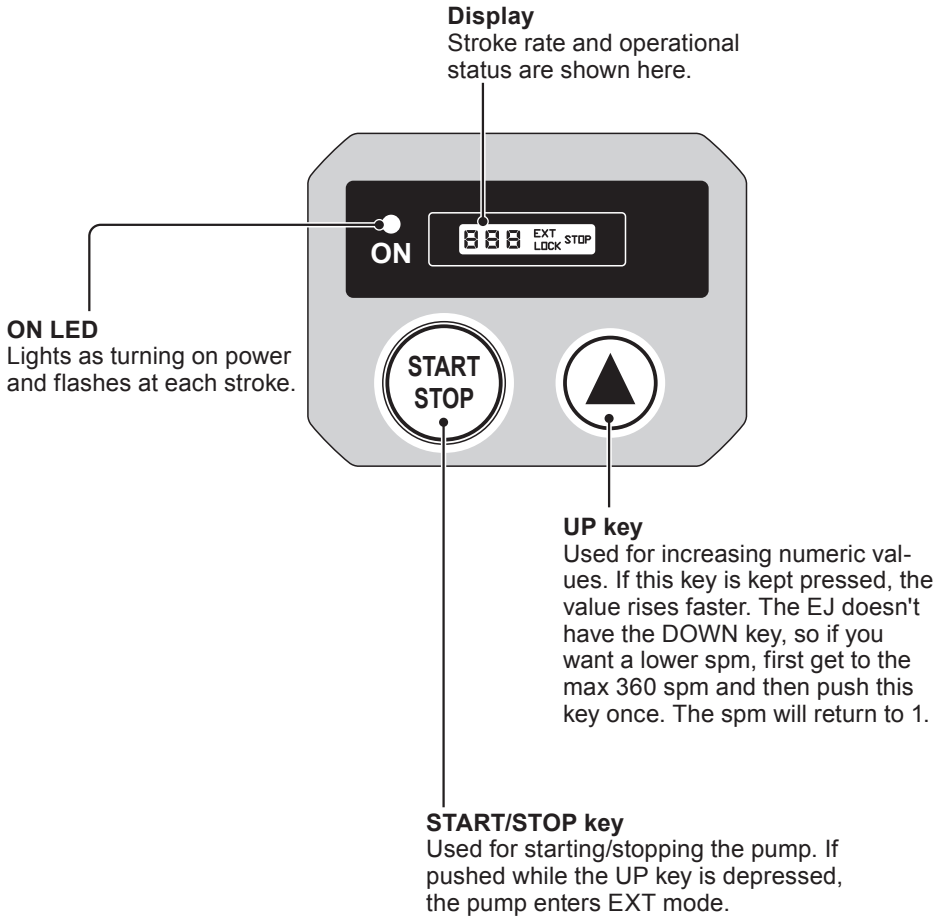

■ Basic displays & Pump states

Shows a pump speed in spm. The spm flashes during operation in MAN and EXT modes. The indication changes to "- - -" when the pump enters maintenance mode.

Represents the pump is in EXT mode.



Represents the pump is receiving the STOP signal.

Represents keypads are locked.

Display info	ON LED lights	ON LED flashes (in sync with each shot)
	A wait state in MAN mode: The display shows the MAN speed in spm.	Operation in MAN mode: A current spm flashes (not in sync with a pump shot).
	—	Operation in EXT mode: A current spm flashes (not in sync with a pump shot).
	STOP signal is entered in MAN mode. If the spm flashes, it means the pump is just suspended and will restart as the signal is turned OFF.	—
	STOP signal is entered in EXT mode. If the spm flashes, it means the pump is just suspended and will restart as the signal is turned OFF.	—
 	—	Keypads are locked and any key operation is cancelled.
 	Keypads are locked in a suspended MAN/EXT mode with the STOP signal.	—
	The pump is in maintenance mode. When extending the diaphragm, the display flashes.	—

Identification codes

The model codes of the pump/drive units represent the following information.

EJ - B 11 VC **E R** -
a b c d e f g h i

a. Series name

EJ: Multivoltage electromagnetic metering pump

b. Drive unit (Average power consumption)

B: 15W

c. Diaphragm effective diameter

09: 8mm 11: 10mm 16: 15mm 21: 20mm

d. Wet end materials

Code	Pump head	Valve	O ring	Valve seat	Gasket	Diaphragm
VC	PVC	Alumina ceramic	FKM	FKM	PTFE	PTFE + EPDM (EPDM is not a wet end.)
VH		HC276	EPDM	EPDM		
TC	PVDF	Alumina ceramic	FKM	FKM		

Material code

PVC: Transparent polyvinyl chloride

HC276: HASTELLOY C276

EPDM: Ethylene-propylene rubber

PVDF : Polyvinylidene difluoride

FKM : Fluorine-contained rubber

PTFE : Polytetrafluoroethylene

e. Tube I.D.

Area	Europe			Australia		
	VC	VH	TC	VC	VH	TC
No code	ø4×ø6	ø4×ø6	ø4×ø6	ø6×ø8	ø6×ø8	ø6×ø8
1	ø4×ø9	ø4×ø9	—	ø4×ø9	ø4×ø9	—
2	ø4×ø6	ø4×ø6	ø4×ø6	ø4×ø6	ø4×ø6	ø4×ø6
3	ø6×ø8	ø6×ø8	ø6×ø8	ø6×ø8	ø6×ø8	ø6×ø8
7	ø1/4"×ø3/8"	ø1/4"×ø3/8"	ø1/4"×ø3/8"	ø1/4"×ø3/8"	ø1/4"×ø3/8"	ø1/4"×ø3/8"
23	ø6×ø12	—	—	ø6×ø12	—	—
24	ø5×ø8	—	ø5×ø8	ø5×ø8	—	ø5×ø8

f. Power cable

E: European type A: Australian type

g. Control unit function

R: With external control

h. Special version

i. Special configuration

Installation

This section describes the installation of the pump, tubing and wiring. Read through this section before work.

! Observe the following points when installing the pump.

- Risk of electrical shock. Be sure to turn off power to stop the pump and related devices before service is performed.
- If you notice any abnormal or dangerous conditions, suspend operation immediately and inspect/solve problems.
- Do not place explosive or flammable material near the pump.
- Do not use a damaged pump. Use of a damaged pump could lead to an electric shock or death.

Pump mounting

Select an installation location and mount the pump.

Necessary tools

- Four M5 bolts (pump mounting)
- Adjustable wrench or spanner

1 Select a suitable place.

Select a level location, free from vibration, that won't hold liquid. See page 10 for detail. Flooded suction is recommended when handling a gaseous liquid such as sodium hypochlorite.

2 Anchor the pump with the M5 bolts.

Be sure to fix the pump at four points.

NOTE

Select a level location. If the pump is not installed level, output may be affected.

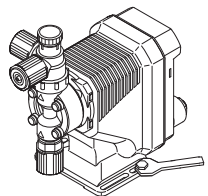

Pipework

Connect tubes to the pump and install a check valve.

Before operation

- Cut the tube ends flat.

Tube end (Side view)

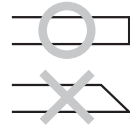

Necessary tools

- Adjustable wrench or spanner

Tube connection

- Pass a tube into the fitting nut and hose stopper and then slide it down to the hose adapter as far as it will go.
- Fit the tube end (hose adapter) to the fitting. Then hand tighten the fitting nut.
- Retighten the fitting nut by turning it 180 degrees with an adjustable wrench or spanner.

*The plastic fitting nut may be broken if it is tightened too much.

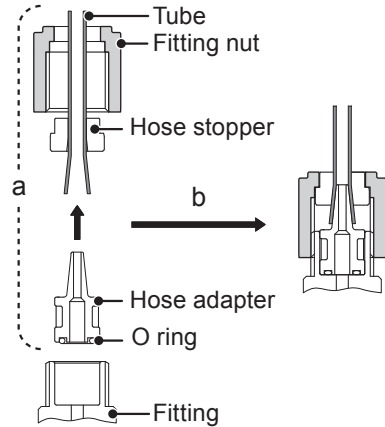

1 Connect tubes into the inlet and outlet.

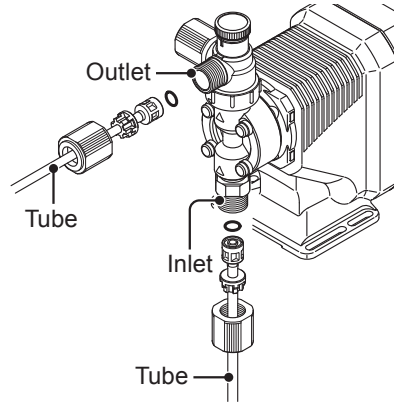

2 Connect an air bleed tube into the air vent port.

Route back the other tube end to a supply tank or a container.

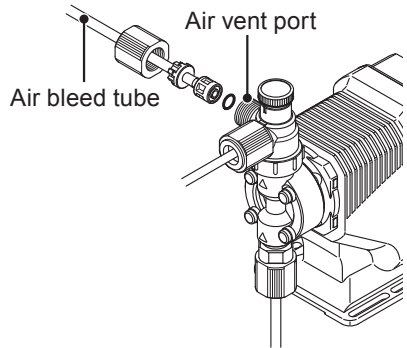

3 Determine an air vent port direction.

The air vent port can rotate 90 degrees.

- a. Turn the lock nut anticlockwise.
- b. Adjust the direction of the air vent port.
- c. Hand-tighten the lock nut, holding the air vent body A.
- d. Turn the lock nut 90 degrees clockwise further with an adjustable wrench or spanner.

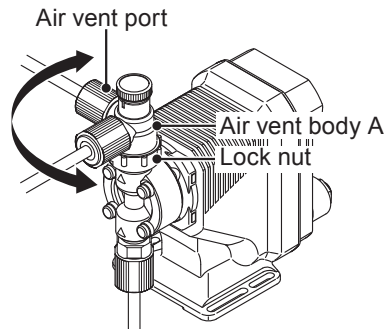

Check valve mounting

Install an optional check valve to the EJ for the prevention of a back flow, siphon and overfeeding. In the following cases be sure to install the check valve.

- A suction side liquid level is higher than a discharge side or an injection point at atmospheric pressure.

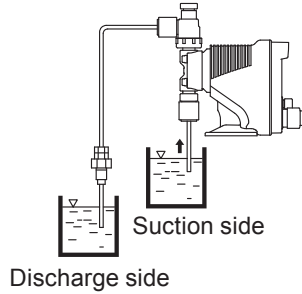

- A discharge side liquid level is higher than a suction side but the distance is 5m or below.

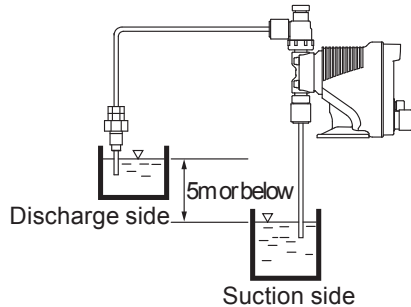

- A suction line pressure is higher than a discharge line pressure.

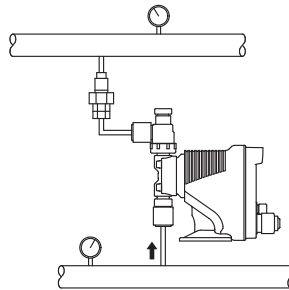

- A discharge pressure (including pipe resistance and discharge head) is below 0.13MPa.

1 Mount a check valve at the discharge tube end.

*The CAN check valve has R1/2 and R3/8 thread connections as well as a $\varnothing 9$ tube connection. Cut off unnecessary sections before use.

CAN check valve

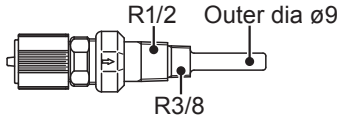

*The CBN check valve of which the both ends are tube connections is also available. Contact us or your nearest distributor.

CBN check valve

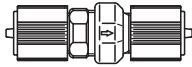

NOTE

Periodically clean or replace a check valve with new one for the prevention of crystal clogging, especially when using sodium hypochlorite.

Tubing layout

Flooded suction application

Suction lift application

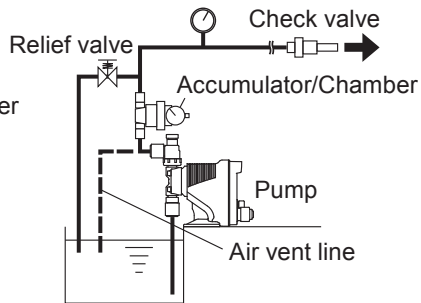
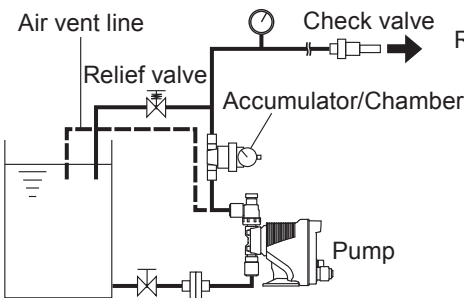

NOTE

Flooded suction is recommended when handling a gaseous liquid such as sodium hypochlorite.

Wiring

Wiring for a power voltage, earthing and an external signal.

! Observe the following points during wiring work.

- Electrical work should be performed by a qualified electrician. Always observe local electric codes.
- Observe the rated voltage range, or the electrical circuit in the control unit may fail.
- Do not perform wiring work while electric power is ON. Otherwise, an electrical shock or a short circuit may result. Be sure to turn off the power before wiring work.
- Be careful for the power not to be turned on during work.
- The power cable is not replaceable.
- The DIN 5-pin male-connector is protected with a protective cap. Do not remove the cap unless the connector is used, or failure may result.

Necessary tools

- Adjustable wrench or spanner
- Phillips screw driver

Power voltage/Earthing

Check that the main power is turned off.

1 Plug the pump into the outlet.

*Make sure the pump is earthed properly.

NOTE

- Do not share a power source with a high power device which may generate surge voltage. Otherwise an electronic circuit may fail. The noise caused by an inverter also affects the circuit.
- Energize the pump with a power voltage via a mechanical relay or switch. Do not fluctuate the voltage, or CPU may malfunction. See page 26 for the precautions for ON-OFF control by a mechanical relay.

Apply power sharply

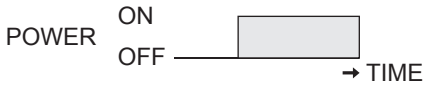

Do not apply gradually



Surge voltage

The electronic circuit in this pump may fail due to surge voltage. Do not place the pump close to a high power device of 200V or more which may generate large surge voltage. Otherwise, take any of the following measures.

- Install a surge absorption element (ex. a varister with capacity of 2000A or more) via power cable.

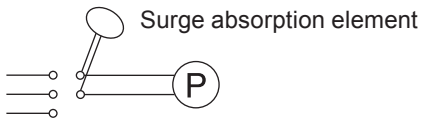

Recommended varisters

SUNTAN TSV14D511K

Panasonic ERZV14D511

See manufacturer's catalogues for detail.

- Install a noise cut transformer via power cable.



Noise cut transformer

Precautions for ON-OFF control by a mechanical relay

This pump is equipped with CPU. Always start/stop the pump by the STOP signal for ON-OFF control. Try not to turn on and off the main power. Otherwise, observe the following points.

- Do not turn ON/OFF power voltage more than six times per hour.
- When using a mechanical relay for ON-OFF operation, its contact capacity should be 5A or more. Contact point may fail if it is less than 5A.
- If a mechanical relay with the contact capacity of 5A is used, the maximum allowable ON/OFF operation is about 150,000 times. The contact capacity should be 10A or more when making ON-OFF operation over 150,000 times or sharing a power source with a large capacity equipment. Otherwise a contact point may fail by surge voltage.
- Use a solid state relay (SSR) as necessary (such as the OMRON G3F). See manufacturer's catalogues for detail.

Signal wire connection

Points to be checked

- Check that the main power is turned off.
The pump is still charged right after turning off power. Wait for one minute before wiring.

Applicable cables

Use our optional connector cables below or purchase DIN 5-pin female connector cables when using signal input.

Binder connector cables

5-pin : 713 series 99-0436-10-05 Input signal.

■ Input signal

To run the pump in EXT mode or to use STOP function, connect signal wires to the EXT terminal via a DIN 5-pin connector.

- *When using an open collector:*

Pay attention to polarity. PIN 1 and 2 are plus (+), and PIN 3 and 4 are minus (-).

- *When using a contact:*

Use a mechanical relay designed for an electronic circuit. Its minimum application load should be 3mA or less.

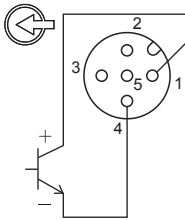

Wiring for
Pulse signal

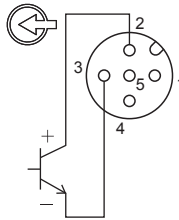

Wiring for
STOP signal

PIN 1 : Pulse (brown)

PIN 2 : STOP (white)

PIN 3 : COM (blue)

PIN 4 : COM (black)

PIN 5 : N.C. (green)

*Each terminal is coloured as above for our optional cable.

The PIN 5 is not used.

NOTE

- Do not lay on these signal cables in parallel with a power cable or combine them in a concentric cable (ex. 5 wires cable). Otherwise noise is generated through the cables due to induction effect and it results in malfunction or failure.
- The following products are the recommended SSRs (Solid State Relays) for signal input. Any other SSRs may cause malfunction. See manufacturer's information for details on these SSRs.
 - OMRON G3FD-102S or G3FD-102SN
 - OMRON G3TA-IDZR02S or G3TA-IDZR02SM
- When using a mechanical relay for signal input, its minimum application load should be 3mA or below.
- Insert the DIN connector as far as it will go and then rotate the outer ring to fix it.
- Our optional cable has 5 wires. Cut off a green wire that is not used.
- PIN 5 is not used. Do not short-circuit it to COM 3 or 4.

*Use either a no-voltage contact or an open collector.

*Set pulse duration in 10-100ms and the number of pulses at or below 360 pulses per minute.

Operation

***This section describes pump operation and programming.
Run the pump after pipework and wiring is completed.***

Before operation

Check a flow rate, tubing and wiring. And then perform degassing and flow rate adjustment before starting operation.

Points to be checked

Before operation, check if...

- Liquid level in a supply tank is enough.
- Tubing is securely connected and is free from leakage and clogging.
- Discharge/suction valves are opened.
- A power voltage is in the allowable range.
- Electrical wiring is correct and is free from the risk of short circuit and electrical leakage.

Retightening of pump head fixing bolts

Important

The pump head fixing bolts may loosen when plastic parts creep due to temperature change in storage or in transit, and this can lead to leakage. Be sure to retighten the bolts evenly to 2.16N•m in diagonal order before starting operation.

*Tighten fixing bolts once every three months.

■ Use of hexagon wrench instead of a torque wrench

Fasten the fixing bolts as tight as can be by the hand with the straight long part of a hexagon wrench (a) and further turn the bolts clockwise 90 degrees with the short part (b).

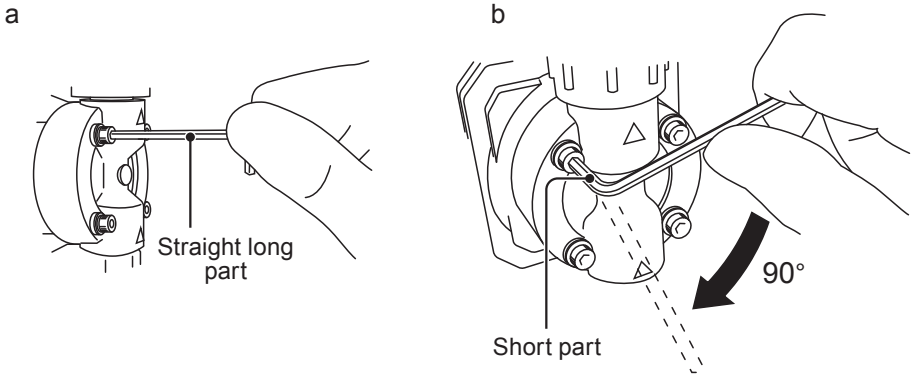

Degassing

The gas needs to be expelled from the pump and tubing by degassing. Normal performance can not be obtained with gas in the pump. Conduct degassing in the following cases.

- When the pump starts to run for the first time
- When a flow rate is too low
- After liquid is replaced in a supply tank
- After a long period of stoppage
- After maintenance and inspection

NOTE

- Both gas and chemical come out together through an air bleed tube. Place the end of the tube in a supply tank or a container.
- Some chemicals may cause skin trouble or damage component parts. When your hand or component parts get wet with chemical liquid, wipe off immediately.

Points to be checked

- An air bleed tube is connected to the pump.

Air bleed tube

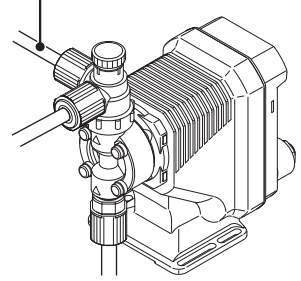

1 Turn on power.

The LED lights and a display related to the current mode appears on the screen.

- *The pump waits in the MAN mode when the power is turned ON with a default setting or calls up the last selected mode with other settings.

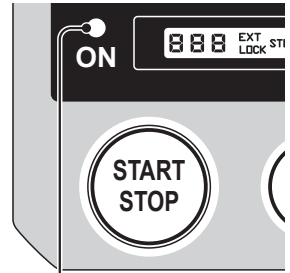

LED

2 Use the UP key to set a stroke rate to 360spm.

- This programming is not necessary when the display already shows 360. Move to the next step.
- If the key is pressed and held, the spm will quickly increases to the max rate.

3 Rotate the adjusting screw two revolutions anticlockwise to open the air vent port.

- *Do not rotate it three revolutions. Otherwise, liquid may come out from the adjusting screw.

Adjusting screw

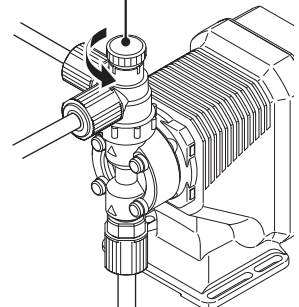

- 4** Push the start/stop key and run the pump for more than ten minutes.

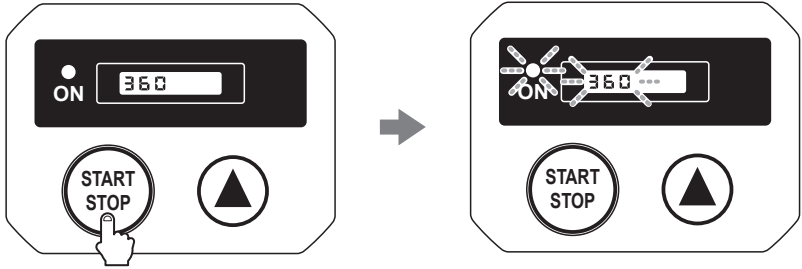

- 5** Push the start/stop key and stop the pump.

- 6** Rotate the adjusting screw clockwise to close the air vent port.

- 7** Check liquid is discharged.

*Degassing is required again if the pump does not discharge liquid.

- 8** Check connections for leakage.
Degassing has now been completed.

Flow rate adjustment

A flow rate can be adjusted only by changing a stroke rate (stroke length adjustment is not available). A stroke rate can be set by keypad operation from 1 to 360spm. The relation between a flow rate* and a stroke rate is shown as below.

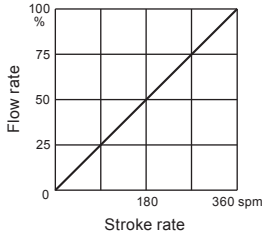

*The discharge capacity described on the nameplate is the value at 100%.

1 Turn on power and call up manual mode.

Enter manual mode to indicate a stroke rate on the screen.

- Push the start/stop key when the pump is in the EXT mode.
- When "STOP" appears on the screen, suspend the STOP signal.

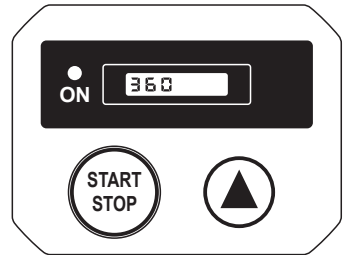

2 Determine a stroke rate that will meet a required flow.

See the above table.

3 Use the UP key to adjust a stroke rate.

- spm increases as pushing the UP keys.
- Press and hold the key for three seconds for quick increment. Quick increment stops at 360spm. 360spm skips to 1spm when the key is released and pushed once.

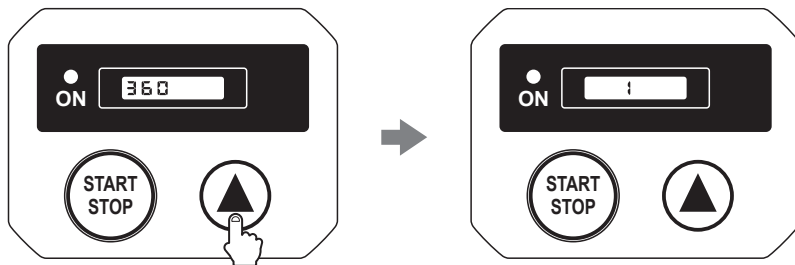

4 Measure a flow rate.

5 If a flow rate is lower than a specified level, increase a stroke rate.

6 Measure the flow again to see the specified level is obtained.

Before a long period of stoppage (one month or more)

Clean wet ends and the inside of tubing.

- Run the pump with clean water for about 30 minutes to rinse chemicals off from the pump head and piping.

Before unplugging the pump

- Always stop the pump by key operation and wait for three seconds before unplugging the pump. Otherwise, the last key operation may not be put in memory. In this case the pump unintentionally starts to run as powered on, discharging liquid.

When the pump does not transfer liquid at resuming operation.

- Clean the valve sets and remove foreign matters.
- If gas is in the pump head, expel gas and readjust a flow rate. See "Degassing" on page 29 and "Flow rate adjustment" on page 32 for detail.

Operation programming

Operation at each mode is individually set and controlled by keypad operation.
 Select a proper mode to make optimal operation.

Programming flow

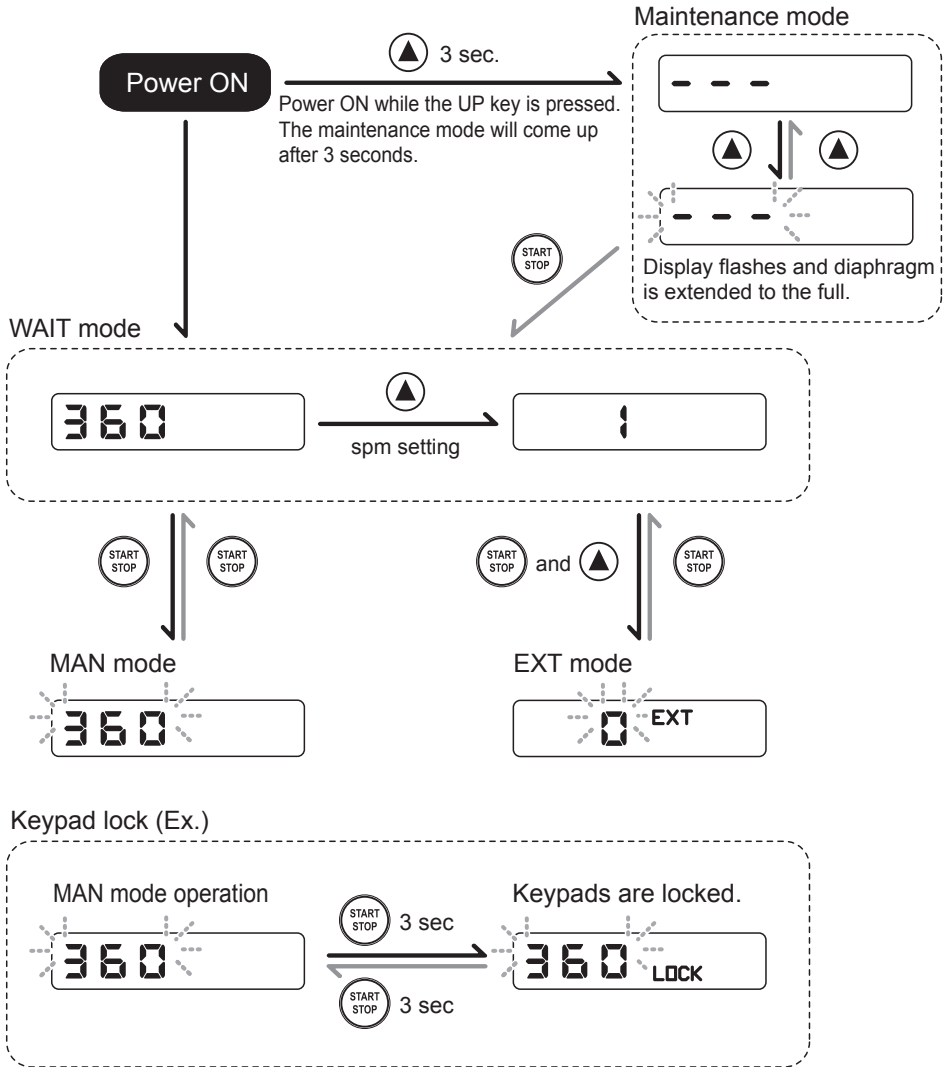

Operation

*The maintenance mode is used for the replacement of a diaphragm.

1 Turn on power.

The LED lights and a display related to the current mode appears on the screen.

*The pump waits in the manual mode when the power is turned ON with a default setting or calls up the last selected mode when powered on with other settings.

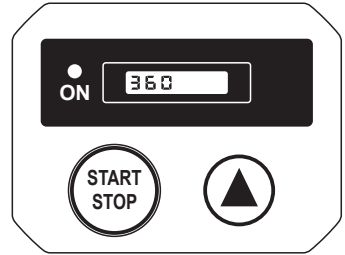

2 Enter WAIT mode.

Move to the next step when spm (1-360) is shown on the screen.

When "EXT" is shown on the screen:

Push the start/stop key once to return to the WAIT mode.

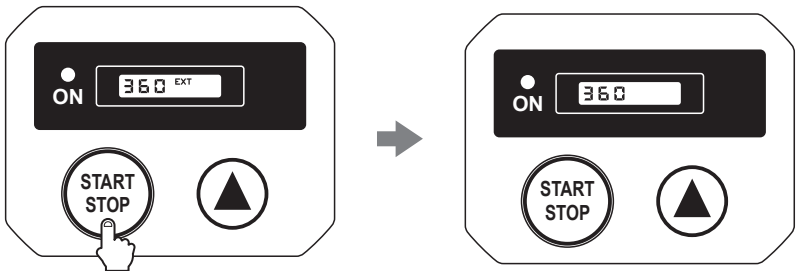

When "STOP" is shown on the screen:

Release the STOP signal.

3 Use the UP key to set a stroke rate.

- spm increases as pushing the UP key.
- Press and hold the key for three seconds for quick increment. Quick increment stops at 360spm. 360spm skips to 1spm when the key is released and pushed once.

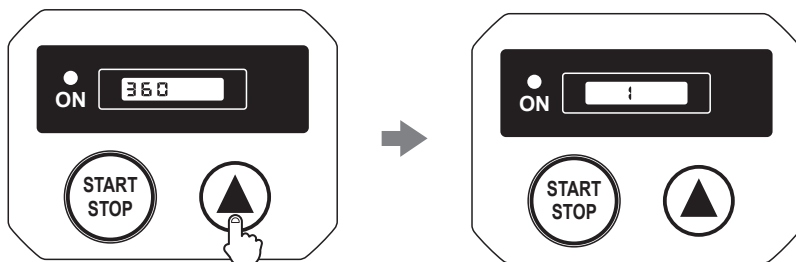

4 Push the start/stop key.

The LED and spm indication blink as the pump starts to run.

*Only the LED blinks in sync with the pump operation.

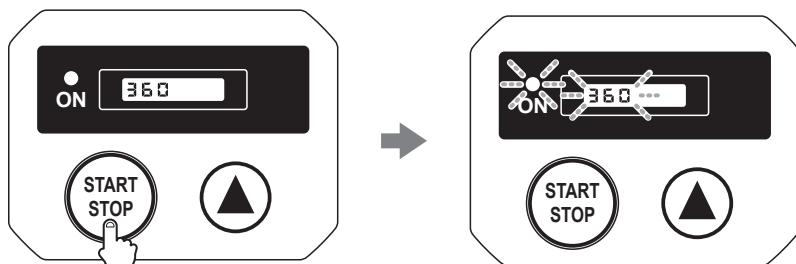

EXT operation

The pump operation is controlled by the external (pulse) signal. In this mode, the pump runs in sync with each external signal.

NOTE

The maximum stroke rate is 360spm in the EXT mode.

1 Enter WAIT mode.

When "EXT" is shown on the screen:

The pump is already in the EXT mode and waiting for the input of the external signal.

When "STOP" is shown on the screen:

Release the STOP signal.

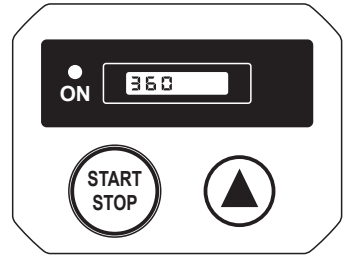

2 Push the UP key while pressing the start/stop key.

The mode changes to the EXT mode and starts running as receiving the external signal.

*The displayed spm shows an actual pump speed in the EXT mode.

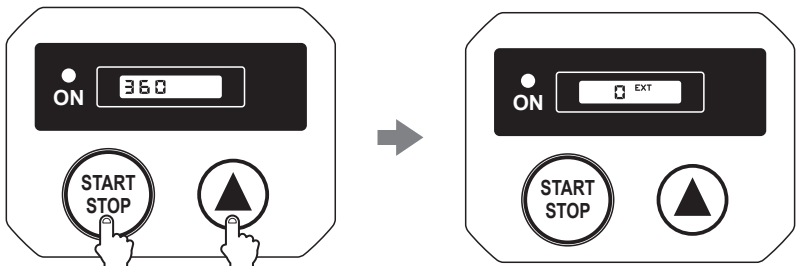

STOP function

The start/stop of the pump operation can be controlled by the external stop signal. The display changes as below when the STOP signal is inputted.

MAN mode

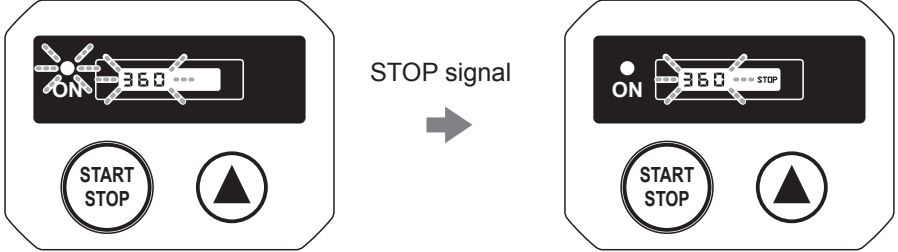

EXT mode

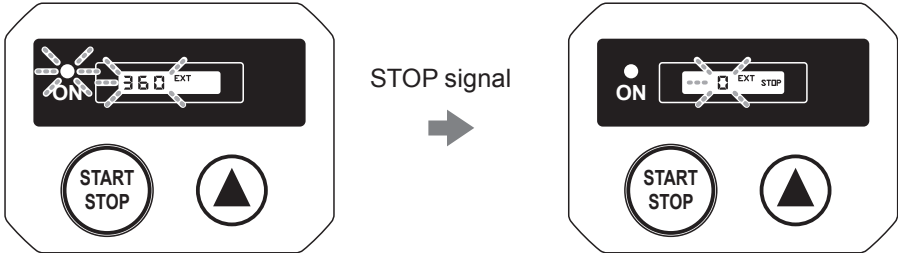

Keypad lock

Keypad lock can be active in the MAN or EXT mode for the prevention of erroneous key operation. The "LOCK" indication appears while keypads are locked.

NOTE

Any key operation is not acceptable when the keypads are locked. In an emergency, unplug the pump to stop operation. Plugging in the pump, keypads are locked again.

■ Keypad lock activation

- 1 Press and hold the start/stop key for three seconds.

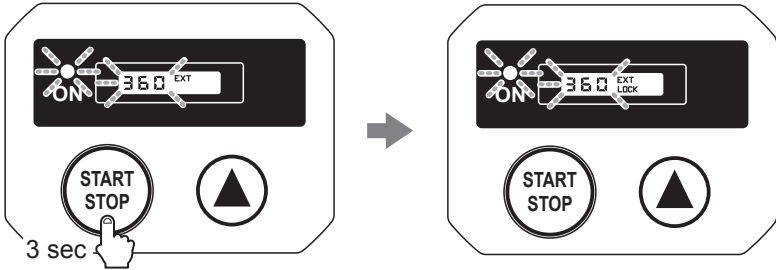

■ Keypad lock release

- 1 Press and hold the start/stop key for three seconds.
Keypad lock is released and key operation becomes acceptable.

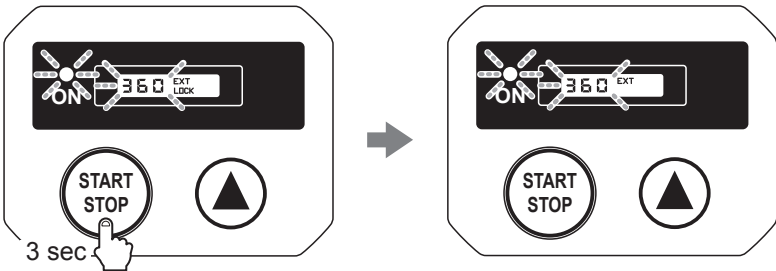

Maintenance

This section describes troubleshooting, inspection, wear part replacement, exploded views and specifications.

! Important

- Follow instructions in this manual for replacement of wear parts. Do not disassemble the pump beyond the extent of the instructions.
- Always wear protective clothing such as an eye protection, chemical resistant gloves, a mask and a face shield during disassembly, assembly or maintenance work. The specific solution will dictate the degree of protection. Refer to MSDS precautions from the solution supplier.
- Risk of electrical shock. Be sure to turn off power to stop the pump and related devices before service is performed.

Before unplugging the pump

Always stop the pump by key operation. And wait for three seconds before unplugging the pump. Otherwise, the last key operation to stop the pump may not be put in memory. In this case the pump unintentionally starts to run as powered on, discharging liquid.

Troubleshooting

First check the following points. If the following measures do not help removing problems, contact us or your nearest distributor.

States	Possible causes	Solutions
The pump does not run (blank LED or screen).	Power voltage is too low.	<ul style="list-style-type: none"> Observe the allowable voltage range of 90-264VAC
	The pump is not powered.	<ul style="list-style-type: none"> Check the switch if it is installed. Correct wiring. Replace a breaking wire to new one.
	A PCB has failed.	<ul style="list-style-type: none"> Replace the pump.
Liquid can not be pumped up.	Air lock in the pump	<ul style="list-style-type: none"> Expel air. See page 29.
	Air ingress through a suction line.	<ul style="list-style-type: none"> Correct tubing.
	A valve set is installed upside down.	<ul style="list-style-type: none"> Reinstall the valve set.
	Valve gaskets are not installed.	<ul style="list-style-type: none"> Install valve gaskets.
	Foreign matters are stuck in the pump head valves.	<ul style="list-style-type: none"> Dismantle, inspect and clean the valves. Replace as necessary.
	A ball valve is stuck on a valve seat.	<ul style="list-style-type: none"> Dismantle, inspect and clean the valve. Replace as necessary.
A flow rate fluctuates.	Air stays in the pump head.	<ul style="list-style-type: none"> Expel air. See page 29.
	Overfeeding occurs.	<ul style="list-style-type: none"> Mount a check valve. See page 22.
	Foreign matters are stuck in the pump head valves.	<ul style="list-style-type: none"> Dismantle, inspect and clean the valves. Replace as necessary.
	Diaphragm is broken.	<ul style="list-style-type: none"> Replace diaphragm.
	Pressure fluctuates at an injection point.	<ul style="list-style-type: none"> Maintain a pressure constant at an injection point by optimizing tubing or by relocating the point.
Liquid leaks.	The fitting or the air vent body is mounted loose.	<ul style="list-style-type: none"> Retighten as necessary.
	The pump head is mounted loose.	<ul style="list-style-type: none"> Retighten as necessary. See page 28.
	O rings or valve gaskets are not installed.	<ul style="list-style-type: none"> Install O rings and valve gaskets.
	Diaphragm is broken.	<ul style="list-style-type: none"> Replace the diaphragm.
	Excessive discharge pressure.	<ul style="list-style-type: none"> Check that a discharge line is not closed. Check if tubing is not clogged.

Inspection

Perform daily and periodic inspection to keep pump performance and safety.

Daily inspection

Check the following points. Upon sensing abnormality, stop operation immediately and remove problems according to "Troubleshooting".

When wear parts come to the life limit, replace them with new ones. Contact us or your nearest distributor for detail.

No.	States	Points to be checked	How to check
1	Pumping	• If liquid is pumped.	Flow meter or visual inspection
		• If the suction and discharge pressure are normal.	Check specifications.
		• If liquid has deteriorated, crystallized or precipitated.	Visual or audio inspection
2	Noise and vibration	• If abnormal noise or vibration occurs. They are signs of abnormal operation.	Visual or audio inspection
3	Air ingress from pump head joints and a suction line	• If leakage occurs. • If pumped liquid includes air bubbles, check lines for leakage and retighten as necessary.	Visual or audio inspection

Periodic inspection

Retighten the pump head mounting bolts evenly to the $2.16N \cdot m$ in diagonal order (once three months).

*Mounting bolts may loosen in operation. How fast the bolts start to loosen is depending on operating conditions.

*A hexagon wrench can be used for a torque wrench. See page 29.



Wear part replacement

To run the pump for a long period, wear parts need to be replaced periodically. It is recommended that the following parts are always stocked for immediate replacement. Contact us or your nearest distributor for detail.

! Precautions

- Solution in the discharge line may be under pressure. Release the pressure from the discharge line before disconnecting plumbing or disassembly of the pump to avoid solution spray.
- Rinse wet ends thoroughly with tap water.
- Each time the pump head is dismantled, replace the diaphragm, O rings, and valve sets with new ones.

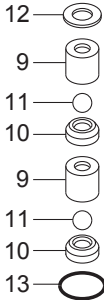
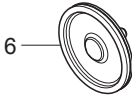
Wear part list

	Parts	# of parts	Estimated life
Pump		2 sets	8000 hours
		1	
		See page 52.	

*Wear part duration varies with the pressure, temperature and characteristics of liquid.

*The estimated life is calculated based on the continuous operation with clean water at ambient temperature.

Before replacement

First release pressure from the pump head.

1 Stop the pump operation.

2 Rotate the adjusting screw two revolutions anticlockwise to open the air vent port.

NOTE

Do not rotate it three revolutions or more. Otherwise, the adjusting screw may come off with solution spray.

3 Check the discharge line and the pump head are depressurized.

Liquid pressure is released from the air vent port in the form of solution spray.

NOTE

If pressurized liquid is not expelled, run the pump with an opened air vent port until pressure is removed.

Valve set replacement

■ Discharge valve set disassembly/assembly

Necessary tools

- Adjustable wrench or spanner
- 21mm box wrench
- A pair of tweezers

*Unfix the pump base before disassembly.

1 Loosen the fitting nut to remove a discharge tube and an air bleed tube.

NOTE

Wash out residual liquid or substances.

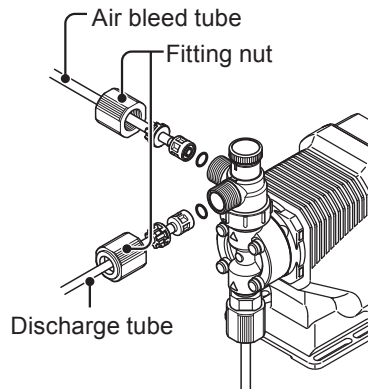

2 Turn the lock nut anticlockwise by an adjustable wrench and remove the air vent body A.

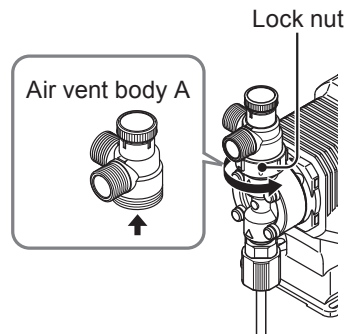

3 Remove the air vent body B with a 21mm box wrench.

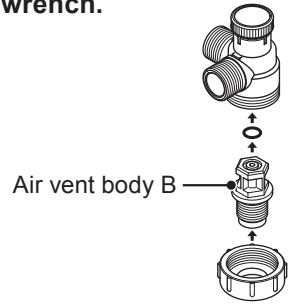

4 Pull out the valve set by a pair of tweezers.

5 Place a new valve set into the pump head and screw the air vent body B through the lock nut.

*Be careful not to misarrange the valve set or place upside down. Otherwise, leakage or flow rate reduction may result.

*Do not forget to fit O rings and gaskets.

*Keep the valve set free from dust or foreign matters.

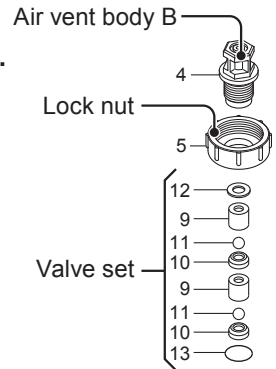

6 Remount the air vent body A and connect tubes.

■ Suction valve set disassembly/assembly

NOTE

Be careful not to drop the valve set.

1 Remove the fitting nut and the suction tube.

NOTE

Wash out residual liquid or substances.

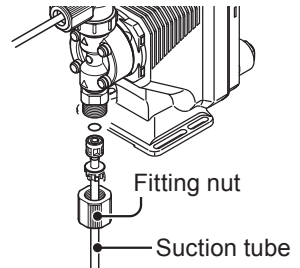

2 Remove the fitting by an adjustable wrench or a spanner.

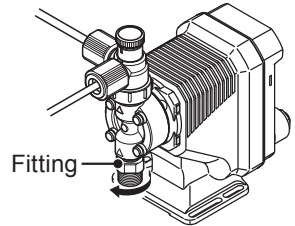

3 Pull out the valve set from the fitting by a pair of tweezers.

4 Place a new valve set into the fitting. Hand-tighten the fitting into the pump head as far as it will go. Retighten it by a further 1/4 turn with an adjustable wrench or a spanner.

*Be careful not to misarrange the valve set or place upside down. Otherwise, leakage or flow rate reduction may result.

*Do not forget to fit O rings and gaskets.

*Keep the valve set free from dust or foreign matters.

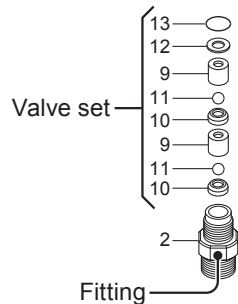

5 Reconnect the suction tube.

Diaphragm replacement

Necessary tools

- Adjustable wrench or spanner
- Hexagon wrench
- Torque wrench

NOTE

- Pay attention not to loose diaphragm spacers. Always apply a proper number of diaphragm spacers. 0 or a few diaphragm spacers are inserted between the retainer and plunger for the adjustment of diaphragm location. Note that the number of diaphragm spacers varies with pump model.
- Do not access the pump in or right after operation. Wait until the drive unit of the pump cools down.

1 Loosen the fitting nuts and remove a suction tube, a discharge tube and an air bleed tube.

2 Remove the pump head with a hexagon wrench.

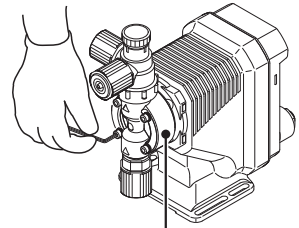

Pump head

3 Enter the pump into maintenance mode.

Press and hold the UP key and then turn ON the power. Keep the key depressed until the maintenance mode is called up.

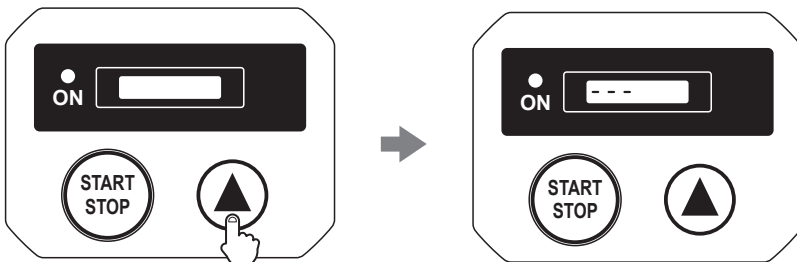

3 sec after powered ON

4 Push the UP key to extend the pump shaft to the full.

*LCD flashes while the shaft is extended.

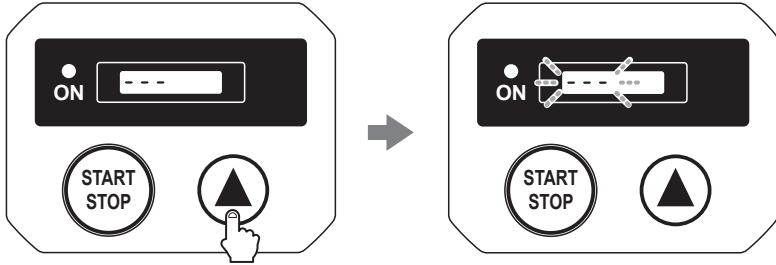

NOTE

- Do not extend the shaft any purposes other than the replacement of the diaphragm.
- Do not keep the shaft extended for 10 minutes or more. Push the UP key again to retract the shaft once the time has passed.

5 Rotate and remove the diaphragm from the plunger (pump shaft).

6 Slide a retainer and diaphragm spacer(s) onto the screw of a new diaphragm.

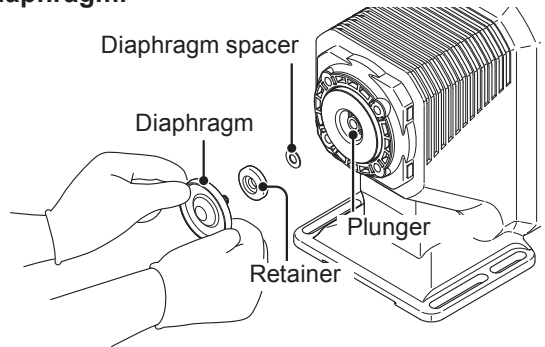

7 Screw the new diaphragm into the plunger as far as it will go.

*Be careful not to loose the retainer and diaphragm spacer.

8 Push the UP key again to contract the pump shaft to the minimum.

9 Push the start/stop key to enter the WAIT mode.

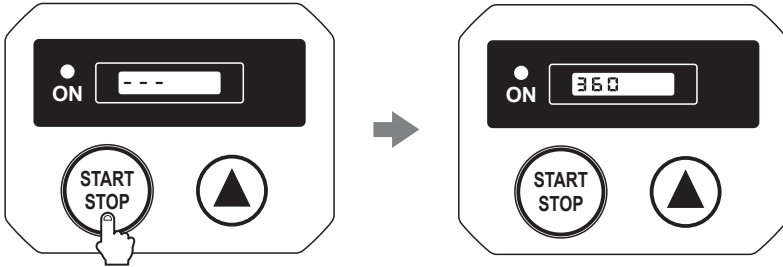

10 Mount the pump head.

Tighten the pump head fixing bolts evenly to 2.16N·m in diagonal order.

*A hexagon wrench can be used for a torque wrench. See page 29.

Exploded view

Pump head & Drive unit

The pump in the diagram below is completely dismantled. Do not dismantle the pump beyond the extent shown in this instruction manual.

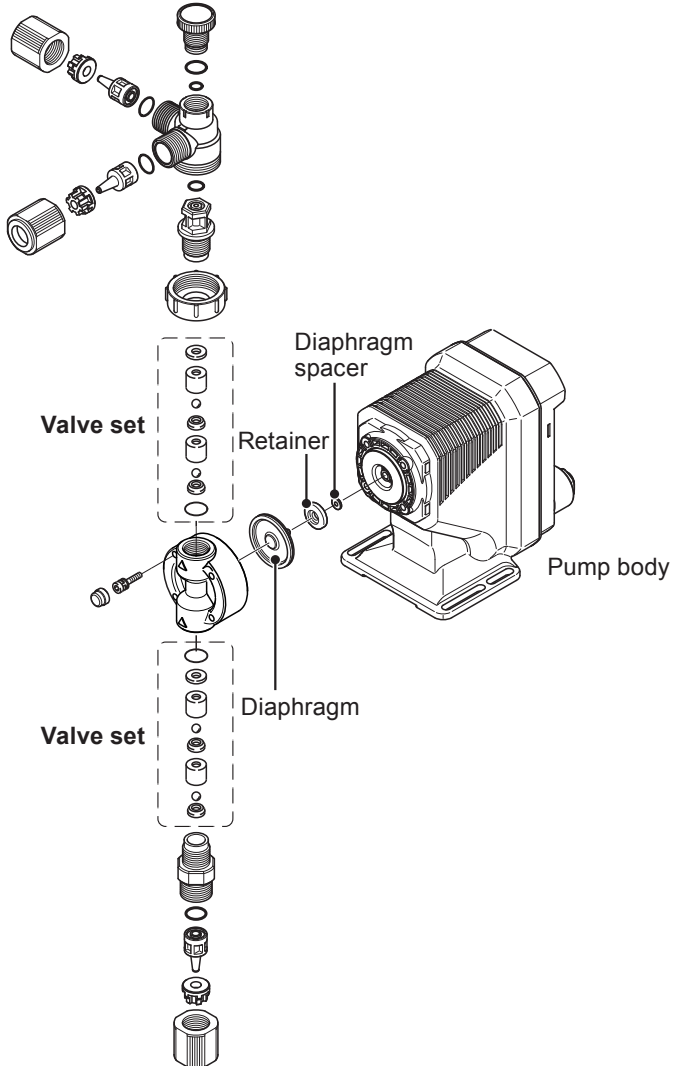

Pump head

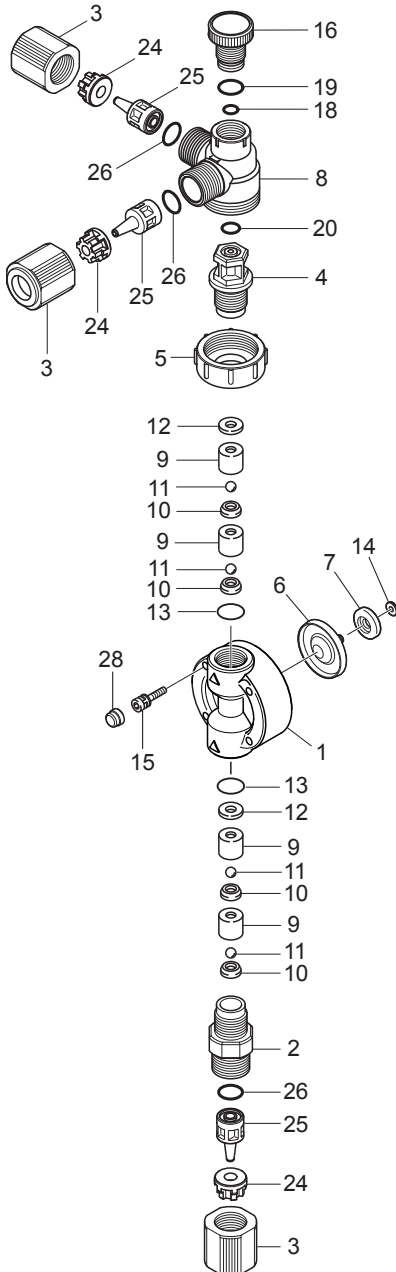

No.	Part names	# of parts
1	Pump head	1
2	Fitting	1
3	Fitting nut	3
4	Air vent body B	1
5	Lock nut	1
6	Diaphragm	1
7	Retainer	1
8	Air vent body A	1
9	Valve guide	4
10	Valve seat	4
11	Valve	4
12	Valve gasket	2
13	O ring	2
14	Diaphragm spacer	*
15	Hex. socket head bolt [PW•SW]	4
16	Adjusting screw	1
18	O ring (P4)	1
19	O ring (P10A)	1
20	O ring (P10)	1
24	Hose stopper	3
25	Hose adaptor	3
26	O ring (P9)	3
28	Bolt cover	4

*The number of diaphragm spacers varies with pump model.

Specifications

Information in this section is subject to change without notice.

■ Pump unit

Model code	Flow rate L/H (m ^l /min)	Discharge pressure MPa	Stroke rate spm	Power con- sumption W	Current value A	Weight kg
EJ-B09	1.14 (19)	1.2	1-360	15	0.8	1.5
EJ-B11	1.8 (30)	1.0				
EJ-B16	3.0 (50)	0.6				
EJ-B21	4.8 (80)	0.3				

*The above information is based on pumping clean water at rated voltage and ambient temperature.

*Flow rates were collected at the maximum discharge pressure and 360spm. A flow rate increases as a discharge pressure decreases.

*Allowable ambient temperature: 0-40°C

*Allowable liquid temperature: 0-40°C (VC/VH) or 0-60°C (TC)

*Allowable power voltage deviation: ±10% of the rated voltage

*Maximum noise level: 65dB at 1m (A scale)

■ Control unit

Operation mode	Mode	Manual
		EXT
Stroke rate	Mode selection	Key operation
	Setting range	1-360spm
	Spm programming	UP key
STOP function	Input signal	No-voltage contact or open collector*1
EXT mode	Maximum spm	360 spm
	Pump behaviour	1 shots per signal*2
	Input signal	No-voltage contact or open collector*1
Monitors	LCD	7×3 LCD with three status codes
	LED	Green LED×1 (blinks at each shot)
Buffer		Non-volatile memory
Power voltage*3		100-240VAC 50/60Hz

*1 The maximum applied voltage from the EJ to an external contact is 15V at 3mA. When using a mechanical relay, the minimum application load should be 3mA or below.

*2 When the external pulse signal is entered to run the pump over the max spm, the signal is cancelled.

*3 Observe the allowable voltage range of 90-264VAC. Otherwise failure may result.

■ European power cable

Conduction section area	0.75 [mm ²] triplex cable (L/N/PE)
Length	2000 [mm]
Standard	H03VV-F
Terminal treatment	European plug

■ Australian power cable

Conduction section area	1.0 [mm ²] triplex cable (L/N/E)
Length	2000 [mm]
Standard	H05VV-F, AS3191
Terminal treatment	Australian plug

■ Pump colour

Blue	Munsell colour system 7.5PB 3/8
Red	Munsell colour system 5R 3/10

Outer dimensions

■ EJ-B09/-B11/-B16/-B21 VC/VH

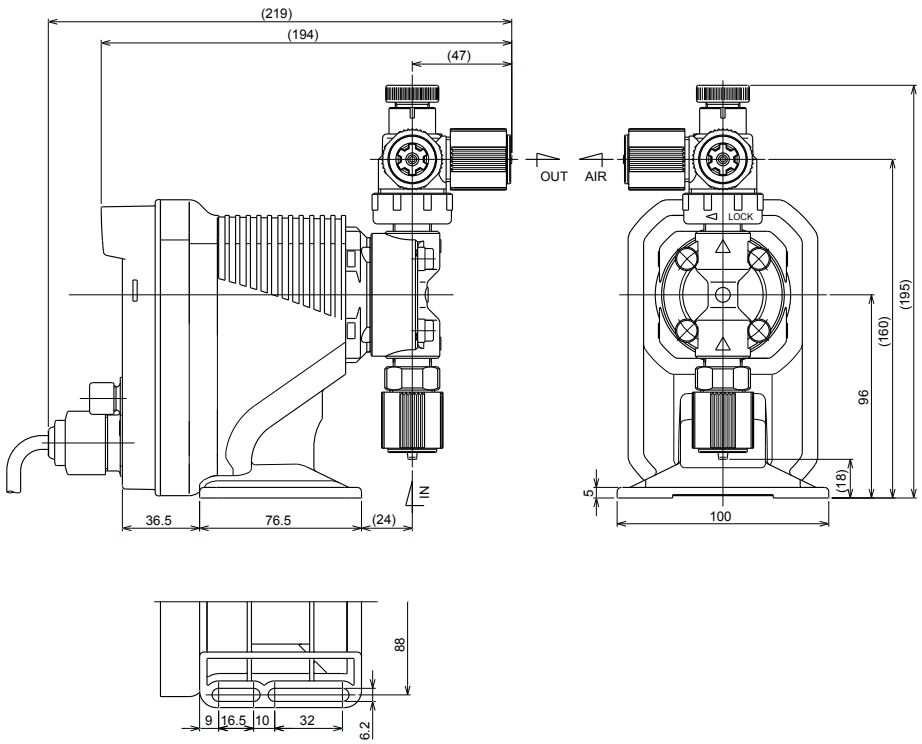

■ EJ-B11/-B16/-B21 TC

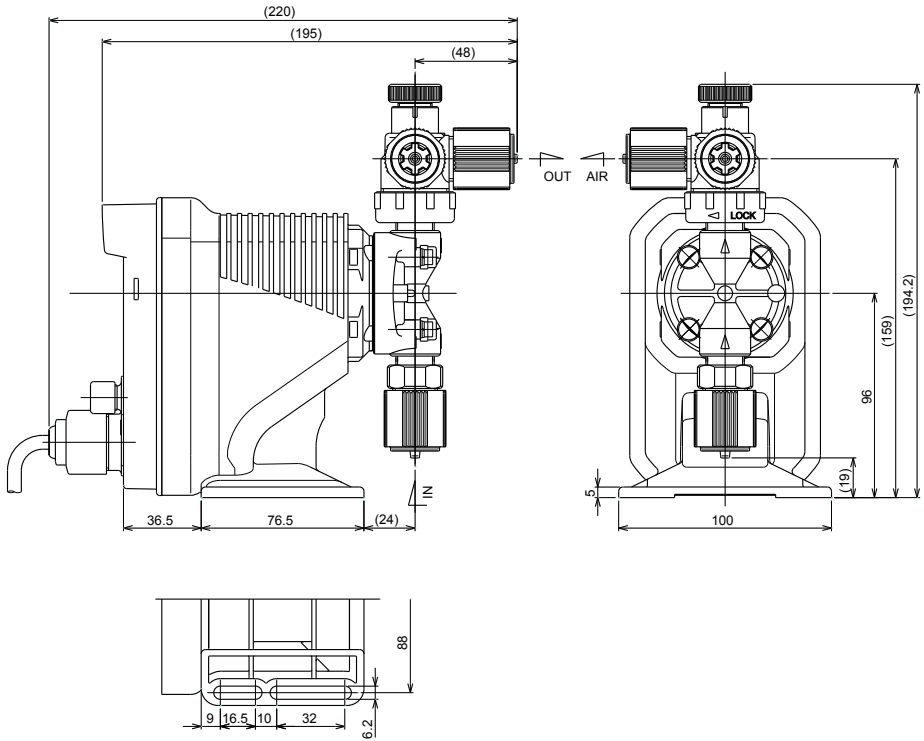

EC Declaration of Conformity

(SUPPLIER'S NAME) WE IWAKI CO.,LTD.	
(ADDRESS) 6-6 2-CHOME KANDA-SUDACHO CHIYODA-KU TOKYO JAPAN	
(PRODUCT) DECLARE UNDER OUR SOLE RESPONSIBILITY THAT THE PRODUCTS ELECTROMAGNETIC METERING PUMP	
(MODEL NAME) EJ-B	
TO WHICH THIS DECLARATION RELATES ARE IN CONFORMITY WITH THE FOLLOWING STANDARDS OR DIRECTIVES AS FAR AS APPLICABLE (DIRECTIVES) MACHINERY DIRECTIVE 2006/42/EC (Annex IIA) LOW VOLTAGE DIRECTIVE 2006/95/EC EMC DIRECTIVE 2004/108/EC	
(STANDARDS) EN809:1998+A1:2009 EN60335-1:2002+A14:2010 ENISO12100-2:2003 EN61000-6-2:2005 EN61000-6-3:2007+A1:2011	
(A PERSON WHO AUTHORISED TO COMPILE THE TECHNICAL FILE IN THE COMMUNITY) AKIRA AIYAMA IWAKI EUROPE GMBH SIEMENSRING 115 D-47877 WILLICH GERMANY	
NOTE: THIS DECLARATION BECOMES INVALID IF TECHNICAL OR OPERA- TIONAL MODIFICATIONS ARE INTRODUCED WITHOUT THE MANUFAC- TURER'S CONSENT.	
<i>Tokyo July 9, 2013</i> (PLACE AND DATE OF ISSUE)	 CHIKARA MATSUSHITA SENIOR GENERAL MANAGER, PRODUCTION HEAD OFFICE (NAME AND SIGNATURE OR EQUIVALENT MARKING OF AUTHORIZED PERSON)
DOCUMENT NO. <u>IS-51K-430</u>	

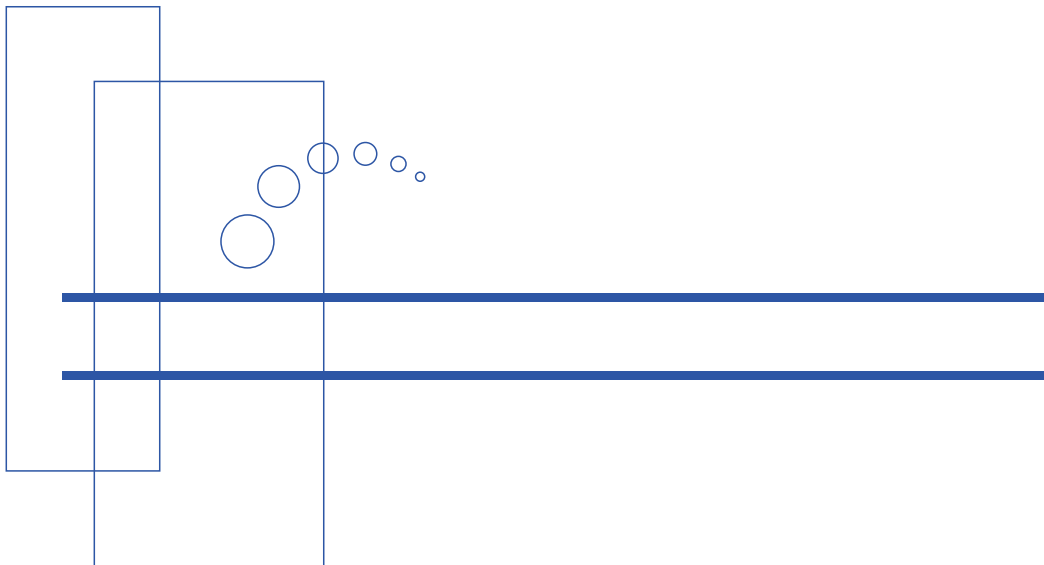

Official IWAKI Distributor

iP Service SA

Route du Pra Rond 4
CH-1785 Cressier / FR
Tel.: +41 26 674 93 00 Fax: +41 26 674 93 02
Internet: www.iwaki.ch E-Mail: info@iwaki.ch